

KitchenAid®

RAVIOLI MAKER INSTRUCTIONS



Model KRAV

These attachments have been approved for use with all KitchenAid® household stand mixers and, for best results, should be used with the KitchenAid® Pasta Roller and Cutter Set (KPRA) or the Pasta Sheet Roller (KPSA) attachment, which is sold separately.



1-800-541-6390
Details Inside



FOR THE WAY IT'S MADE.™

Hassle-Free Replacement Warranty – 50 United States and District of Columbia



We're so confident the quality of our products meets the exacting standards of KitchenAid that, if your Ravioli Maker

should fail within the first year of ownership, KitchenAid will arrange to deliver an identical or comparable replacement to your door free of charge and arrange to have your original Ravioli Maker returned to us. Your replacement Ravioli Maker will also be covered by our one year limited warranty. Please follow these instructions to receive this quality service.

If your KitchenAid® Ravioli Maker should fail within the first year of ownership, simply call our toll-free Customer Satisfaction Center at **1-800-541-6390** Monday through Friday, 8 a.m. to 8 p.m. (Eastern Time), or Saturday, 10 a.m. to 5 p.m. Give the consultant your complete shipping address. (No P.O. Box numbers, please.)

When you receive your replacement Ravioli Maker, use the carton and packing materials to pack up your original Ravioli Maker. In the carton, include your name and address on a sheet of paper along with a copy of the proof of purchase (register receipt, credit card slip, etc.) For a detailed explanation of warranty terms and conditions, including how to arrange for service outside the United States, see pages 3 and 4.

Proof of Purchase & Product Registration

Always keep a copy of the sales receipt showing the date of purchase of your ravioli maker. Proof of purchase will assure you of in-warranty service.

Before you use your ravioli maker, please fill out and mail your product registration card packed with the Ravioli Maker. This card will enable us to contact you in the unlikely event of

a product safety notification and assist us in complying with the provisions of the Consumer Product Safety Act. This card does not verify your warranty.

Please complete the following for your personal records:

Model Number _____

Date Purchased _____

Store Name _____

Table of Contents

Hassle-Free Replacement Warranty.....	Inside Front Cover
Product Registration Card	Inside Front Cover
Important Safeguards.....	2
Warranty	3
How to Arrange for Warranty Service in Puerto Rico	4
How to Arrange for Service after the Warranty Expires — All Locations.....	4
How to Arrange for Service Outside these Locations	4
How to Order Accessories and Replacement Parts.....	4
Ravioli Maker Attachment.....	5
Assembling Your Pasta Sheet Roller.....	6
Tips for Exceptional Pasta	6
Preparing Pasta Sheets.....	7
Assembling Your Ravioli Maker	8
Using Your Ravioli Maker	8
Care and Cleaning	10
Helpful Hints	10
Recipes	11

Your safety and the safety of others are very important.

We have provided many important safety messages in this manual and on your appliance. Always read and obey all safety messages.



This is the safety alert symbol.

This symbol alerts you to potential hazards that can kill or hurt you and others.

All safety messages will follow the safety alert symbol and either the word “DANGER” or “WARNING.” These words mean:

⚠ DANGER

You can be killed or seriously injured if you don't immediately follow instructions.

⚠ WARNING

You can be killed or seriously injured if you don't follow instructions.

All safety messages will tell you what the potential hazard is, tell you how to reduce the chance of injury, and tell you what can happen if the instructions are not followed.

IMPORTANT SAFEGUARDS

When using electrical appliances, basic safety precautions should always be followed including the following:

1. Read all instructions.
2. To protect against risk of electrical shock, do not put mixer in water or other liquid.
3. Close supervision is necessary when this or any appliance is used near children.
4. Unplug mixer from outlet when not in use, before putting on or taking off parts and before cleaning.
5. Avoid contacting moving parts. Keep fingers out of hopper inlet and discharge opening.
6. Do not operate the mixer with a damaged cord or plug or after the mixer malfunctions, or is dropped or damaged in any manner. Return the mixer to the nearest Authorized Service Center for examination, repair or electrical or mechanical adjustment.
7. The use of attachments not recommended or sold by KitchenAid may cause fire, electric shock or injury.
8. Do not use the mixer outdoors.
9. Do not let the cord hang over the edge of table or counter.
10. Do not let cord contact hot surface, including the stove.
11. This product is designed for household use only.

SAVE THESE INSTRUCTIONS

KitchenAid® Ravioli Maker Warranty

Length of Warranty:	KitchenAid Will Pay For:	KitchenAid Will Not Pay For:
<p>50 United States, the District of Columbia and Puerto Rico: One-year limited warranty from date of purchase.</p>	<p>50 United States and the District of Columbia: Hassle-free replacement of your Ravioli Maker. See the following page for details on how to arrange for service.</p> <p style="text-align: center;">OR</p> <p>In Puerto Rico: The replacement parts and repair labor costs to correct defects in materials and workmanship. Service must be provided by an Authorized KitchenAid Service Center. To arrange for service, follow the instructions on page 4.</p>	<p>A. Repairs when your Ravioli Maker is used in other than normal single family home use.</p> <p>B. Damage resulting from accident, alteration, misuse or abuse or use with products not approved by KitchenAid.</p> <p>C. Replacement parts or repair labor costs for your Ravioli Maker when operated outside the country of purchase.</p>

DISCLAIMER OF IMPLIED WARRANTIES; LIMITATION OF REMEDIES

IMPLIED WARRANTIES, INCLUDING TO THE EXTENT APPLICABLE WARRANTIES OF MERCHANTABILITY OR FITNESS FOR A PARTICULAR PURPOSE, ARE EXCLUDED TO THE EXTENT LEGALLY PERMISSIBLE. ANY IMPLIED WARRANTIES THAT MAY BE IMPOSED BY LAW ARE LIMITED TO ONE YEAR, OR THE SHORTEST PERIOD ALLOWED BY LAW. SOME STATES DO NOT ALLOW LIMITATIONS OR EXCLUSIONS ON HOW LONG AN IMPLIED WARRANTY OF MERCHANTABILITY OR FITNESS LASTS, SO THE ABOVE LIMITATIONS OR EXCLUSIONS MAY NOT APPLY TO YOU.

IF THIS PRODUCT FAILS TO WORK AS WARRANTED, CUSTOMER'S SOLE AND EXCLUSIVE REMEDY SHALL BE REPAIR OR REPLACEMENT ACCORDING TO THE TERMS OF THIS LIMITED WARRANTY.

KITCHENAID DOES NOT ASSUME ANY RESPONSIBILITY FOR INCIDENTAL OR CONSEQUENTIAL DAMAGES. This warranty gives you specific legal rights and you may also have other rights that vary from state to state.

How to Arrange for Warranty Service in Puerto Rico

Your KitchenAid® Ravioli Maker is covered by a one-year limited warranty from the date of purchase. KitchenAid will pay for replacement parts and labor costs to correct defects in materials and workmanship. Service must be provided by an Authorized KitchenAid Service Center.

Take the Ravioli Maker or ship prepaid and insured to an Authorized KitchenAid Service Center. Your repaired Ravioli Maker will be returned prepaid and insured. If you are unable to obtain satisfactory service in this manner, call toll-free **1-800-541-6390** to learn the location of a Service Center near you.

How to Arrange for Service after the Warranty Expires — All Locations

For service information in the 50 United States, District of Columbia, and Puerto Rico, call toll-free 1-800-541-6390.

Or write to:
Customer Satisfaction Center
KitchenAid Portable Appliances
P.O. Box 218
St. Joseph, MI 49085-0218

Or contact an Authorized Service Center near you.

How to Arrange for Service Outside these Locations

Consult your local KitchenAid dealer or the store where you purchased the

Ravioli Maker for information on how to obtain service.

How to Order Accessories and Replacement Parts

To order accessories or replacement parts for your Ravioli Maker in the 50 United States, District of Columbia, and Puerto Rico, call toll-free **1-800-541-6390** Monday through Friday, 8 a.m. to 8 p.m. (Eastern Time), or Saturday, 10 a.m. to 5 p.m.

Or write to:
Customer Satisfaction Center,
KitchenAid Portable Appliances, P.O.
Box 218, St. Joseph, MI 49085-0218.

Ravioli Maker Attachment

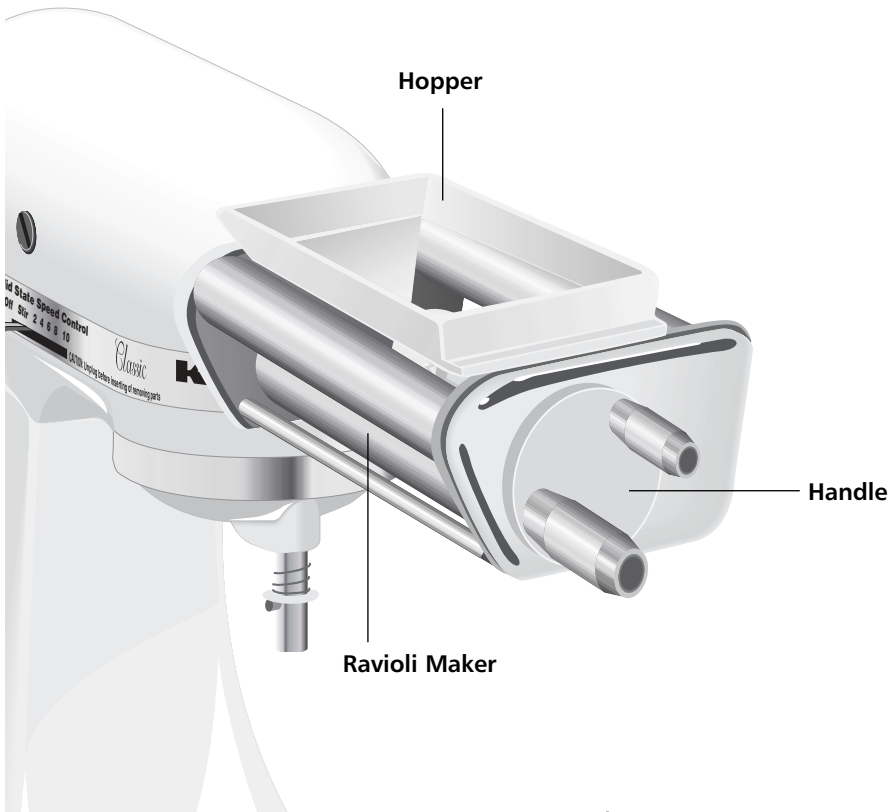

Ravioli Maker — Fills sheets of pasta with filling, then crimps the edges for strips of stuffed pasta that after drying can be separated for cooking. Ravioli Maker attaches to the stand mixer for stability, but is operated manually for precise control.

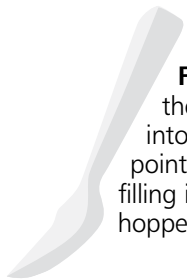

Filling Scoop — Use the scoop to spoon filling into the hopper. The special pointed shape helps spread filling into the corners of the hopper for even distribution.



Cleaning Brush — Use to brush away dried dough after use.

NOTE: This attachment is designed to be used with pasta dough only. Do not cut or roll any other material or food with Ravioli Maker.

NOTE: To avoid damaging the Ravioli Maker:

- Do not wear ties, scarves, or long necklaces when using.
- Gather long hair with a clasp before using.

Assembling Your Pasta Sheet Roller

(Purchased Separately)

If you do not own a KitchenAid® Pasta Sheet Roller, pasta sheets can be prepared by hand. Pasta sheets should be rolled out to a thickness of $\frac{1}{16}$ inch and a width of $5\frac{1}{2}$ inches in order to pass through the Ravioli Maker.

To Attach Pasta Sheet Roller:

Remove “Do not immerse in water” label, prior to use.

To attach accessory:

1. Turn OFF and unplug mixer.
2. Depending on which type of hub you have, either flip up hinged cover or loosen attachment knob (A) by turning it counterclockwise and remove attachment hub cover (B).

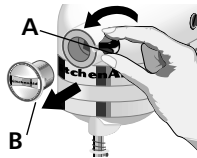

3. Select Pasta Sheet Roller attachment.

Insert attachment shaft housing (C) into attachment hub (D), making

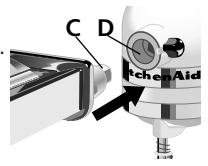

certain that the power shaft fits into recessed, square hub socket. Rotate attachment back and forth if necessary. When attachment is in proper position, the pin on the attachment housing (E) will fit into the notch (F) on the hub rim.

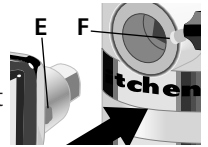

4. Tighten attachment knob (A) until Pasta Sheet Roller is completely secured to mixer.
5. Plug in mixer.

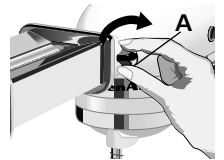

Tips for Exceptional Pasta

- Good pasta dough is firm and leathery to touch, but also pliable. It should never stick to your fingers or crumble and fall apart. Many factors, such as humidity, brand of flour used, and size of eggs, may affect dough consistency.
- To test for correct dough consistency, pinch a small amount of dough together after mixing with the flat beater. If the dough stays together without sticking to your fingers, it should work well. It may be necessary to add a small amount of flour or water to reach correct dough consistency.
- If using Ravioli Maker for the first time, practice feeding pasta without filling through the attachment to perfect your technique.
- Separated ravioli can be cooked right away or stored in the refrigerator overnight. For longer storage individually freeze ravioli on baking sheet. Then store in freezer in sealed container.
- Cook ravioli in 6 quarts salted, boiling water until al dente or slightly firm to the bite, approximately 3 to 4 minutes.

Preparing Pasta Sheets

1. Prepare pasta dough and let rest at least 10 minutes. Cut dough into sections approximately the size of a tennis ball and work with one section at a time. Wrap remaining dough in plastic wrap to keep from drying out.



2. Adjust Pasta Sheet Roller to setting 1 (Pasta Sheet Roller settings are adjusted by pulling out and turning the knob on the front of the attachment).



Turn the stand mixer to Speed 2 or 4 and feed dough into the Pasta Sheet Roller.



3. Fold dough in half and roll again. Repeat folding and kneading process several times or until dough is smooth and elastic. Lightly dust pasta with flour while rolling to aid in drying and separation.

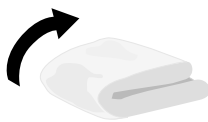

4. Move the Pasta Sheet Roller adjustment knob to setting 2. Feed the dough through



5. Using a knife, trim each end of the dough sheet.
6. Lightly dust the rollers of the ravioli maker with flour.
7. To clean Pasta Sheet Roller, let parts air dry for one hour and then remove any dried dough using the Cleaning Brush. If dried dough cannot be removed, try hand-tapping the attachment. A toothpick can be used if necessary. Never use a knife or other sharp object to remove excess dough. Polish with a soft, dry cloth and store attachment pieces in a dry place at room temperature.

NOTE: Never wash or immerse Pasta Sheet Roller attachment in water or other liquid. Never wash in dishwasher.

NOTE: To avoid damaging the Pasta Sheet Roller:

- Do not run a dishtowel or any other cloth through the rollers to clean them.
- Do not insert objects such as knives, screwdrivers, etc., to clean the Pasta Sheet Roller.

Assembling Your Ravioli Maker

To Attach Ravioli Maker:

To attach accessory:

1. Turn OFF and unplug mixer.
2. Depending on which type of hub you have, either flip up hinged cover or loosen attachment knob (A) by turning it counterclockwise and remove attachment hub cover (B).

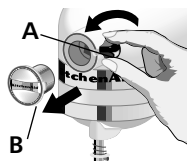

3. Remove Filling Hopper from Ravioli Maker.
4. Insert attachment shaft housing (C) into attachment hub (D). The attachment should be flush to the hub.
5. Tighten attachment knob (A) by turning clockwise until Ravioli Maker is completely secured in mixer.

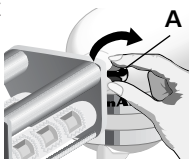
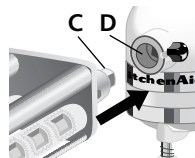

Using Your Ravioli Maker

To Use:

1. Remove hopper from the Ravioli Attachment by pulling upward firmly.
2. Fold pasta sheet in half.

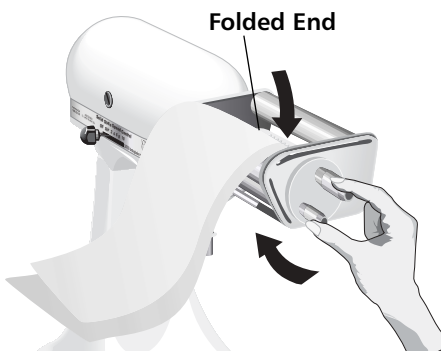

3. To insert the pasta sheet, insert the folded end between the forming rollers. Rotate the handle one quarter of a turn to feed the pasta sheet.

NOTE: Two-knob handle provides precise thumb and forefinger control of rolling and filling. The mixer is not turned on while making ravioli.

4. Separate the two loose ends of the pasta sheet and drape each end over the smooth metal rollers.

Using Your Ravioli Maker

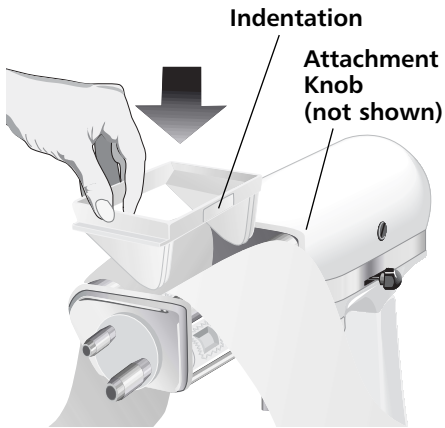

5. Locate the slight indentation on one side of the hopper rim. Position the indented side so it faces the attachment-knob-side of the stand mixer. Place the hopper on top of the dough sheet, between the separated ends, and push down until you hear a click and the side edges of the hopper rest against the Ravioli Maker.

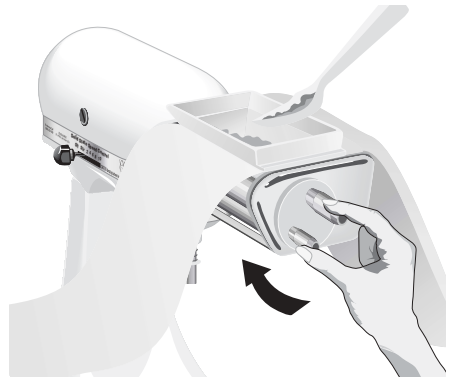

7. Slowly turn the handle. Check that ravioli strips are feeding freely through bottom of attachment.
8. Add more filling to the hopper as needed. Spread the filling evenly into the corners of the hopper and gently press down on the filling with the scoop. Make sure all filling in the hopper is used before the end of the pasta sheet is reached, or the filling will collect on the rollers. Use the scoop to remove extra filling if necessary.



6. Using the provided scoop, spoon 1-2 scoops of filling into the hopper. Spread the filling evenly into the corners of the hopper and gently, evenly press down on the filling with the scoop.



9. Place the strips of ravioli on a lightly floured surface and let them dry for at least 10 minutes. Separate the ravioli one by one, tearing along perforations.
10. Before rolling the next sheet of ravioli strips, clean the attachment by using the brush to lightly dust the rollers with flour.

Care and Cleaning

To clean the Ravioli Maker

1. Dust the attachment with flour and use the brush to clean it.

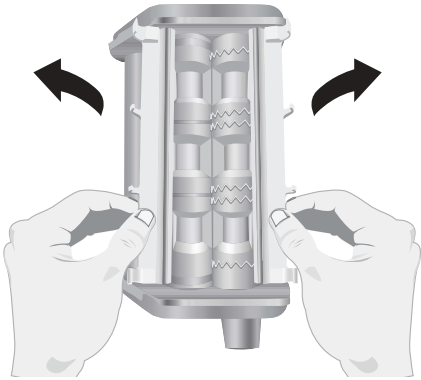

2. Remove the hopper and snap open the thin white plastic guides/levers at the bottom of the attachment for easy access to the rollers. Wash in warm, soapy water.

NOTE: To avoid damaging the Ravioli Maker Attachment:

- Never wash in dishwasher.
- Do not run a dishtowel or any other cloth through the rollers to clean them.
- Do not insert objects such as knives, screwdrivers, etc., to clean the Ravioli Maker.

Helpful Hints

First Time Practice

To perfect your technique, practice feeding pasta through the rollers without adding any filling. Enjoy the smooth and easy manual operation.

Uneven Feeding of Dough

Pasta sheets should be uniformly thick ($\frac{1}{16}$ inch) and wide ($5\frac{1}{2}$ inches). Center the sheets when feeding them into rollers. Lightly dust the pasta with flour to aid in processing.

Is the Dough too Dry?

If dough seems too dry for smooth feeding, add a small amount of water to reach the correct dough consistency. Repeat folding, kneading, and rolling processes to prepare the sheets.

Is the Dough too Wet?

If dough seems too wet for smooth feeding, add a small amount of flour to reach the correct dough consistency. Repeat folding, kneading, and rolling processes to prepare the sheets.

Basic Egg Pasta

- 4 large eggs
($\frac{1}{2}$ cup eggs)
- $\frac{1}{2}$ cup water
- $3\frac{1}{2}$ cups sifted
all-purpose flour
- $\frac{1}{2}$ teaspoon salt

Place eggs, water, flour, and salt in mixer bowl. Attach bowl and flat beater. Turn to Speed 2 and mix 30 seconds.

Exchange flat beater for dough hook. Turn to Speed 2 and knead 2 minutes. Remove dough from bowl and hand knead for 1 to 2 minutes. Let it rest for 20 minutes. Divide dough into 4 pieces before processing with Pasta Sheet Roller attachment.

Follow cooking instructions, page 6.

Yield: $1\frac{1}{4}$ pounds dough.

Pumpkin-Sage Ravioli with Browned Butter and Pecans

- 1 recipe Basic Egg
Pasta
- 1 can (15 oz.) pumpkin
- $\frac{1}{4}$ cup packed brown
sugar
- 1 teaspoon ground
sage
- $\frac{1}{2}$ teaspoon salt
- $\frac{1}{4}$ teaspoon black
pepper
- $\frac{1}{4}$ teaspoon ground
nutmeg
- 6 tablespoons chopped
pecans
- 6 tablespoons butter

Prepare pasta dough; let rest.

In medium bowl, combine pumpkin, sugar, sage, salt, pepper, and nutmeg; refrigerate until ready to fill ravioli. Follow directions for preparing pasta sheets, using ravioli maker and cooking ravioli.*

On baking sheet, place pecans in single layer. Toast in oven at 350°F for 5 to 7 minutes, or until golden brown and aromatic. Meanwhile, in heavy 1-quart saucepan over medium-high heat, heat butter until golden brown. Serve hot butter over cooked ravioli and top with pecans.

Yield: 6 servings (12 to 15 ravioli with 1 tablespoon butter and 1 tablespoon pecans per serving).

*For very moist fillings, such as pumpkin, pasta roller setting 4 works best, and ravioli should be cooked immediately after filling and drying.

Per serving: About 510 cal, 13 g pro, 67 g carb, 21 g total fat, 9 g sat fat, 170 mg chol, 550 mg sod.

Salmon-Cream Cheese Ravioli with Roasted Garlic Cream Sauce

Ravioli

- 1 *recipe Basic Egg Pasta, page 11*
- 1 *fillet (12 oz.) salmon*
- 2-3 *teaspoons olive oil*
- $\frac{1}{4}$ *teaspoon salt*
- $\frac{1}{8}$ *teaspoon black pepper*
- 1 *container (8 oz.) cream cheese with chives and onion*
- 2-3 *teaspoons chopped fresh dill or $\frac{1}{2}$ teaspoon dried dill*

Prepare pasta dough; let rest.

Drizzle salmon with oil; sprinkle with salt and pepper. On greased baking sheet, roast salmon at 400°F for 10 minutes, or until center flakes easily with fork. Cool; remove and discard skin and dark meat. In medium bowl, flake salmon; combine with cream cheese and dill. Refrigerate until ready to fill ravioli. Follow directions for preparing pasta sheets, using ravioli maker and cooking ravioli.

Sauce

- 1 *large head garlic*
- 1 *teaspoon olive oil*
- 1 *tablespoon butter*
- 1 *tablespoon all-purpose flour*
- 1½ *cups whipping cream*
- $\frac{1}{8}$ *teaspoon ground nutmeg*
- $\frac{1}{4}$ - $\frac{1}{2}$ *teaspoon salt*
- $\frac{1}{8}$ *teaspoon black pepper*

Peel loose, paper-like skin from outside of garlic. Cut $\frac{1}{2}$ -inch slice from top of garlic to expose cloves. Place cut side up on 12-inch square of aluminum foil. Drizzle with oil; wrap securely in foil. Bake at 350°F for 45 to 50 minutes, or until knife point in center meets no resistance; cool. In small bowl, squeeze garlic out of cloves; mash with fork.

In heavy 2-quart saucepan over medium heat, heat butter until hot. Stir in flour; cook 1 minute. Gradually stir in cream, mashed garlic, nutmeg, salt, and pepper. Heat to boiling; boil and stir 1 minute, or until thickened. Serve hot over cooked ravioli.

Yield: 6 servings (12 to 15 ravioli with $\frac{1}{4}$ cup sauce per serving).

Per serving: About 750 cal, 28 g pro, 57 g carb, 45 g total fat, 24 g sat fat, 295 mg chol, 680 mg sod.

Chicken, Pine Nut and Goat Cheese Ravioli with Traditional Red Sauce

Ravioli

- 1 *recipe Basic Egg Pasta, page 11*
- $\frac{1}{4}$ *cup pine nuts*
- $\frac{3}{4}$ *cup finely chopped roasted chicken*
- 1 *package (4 oz.) mild goat cheese with garlic and herbs*

Prepare pasta dough; let rest.

On baking sheet, place nuts in single layer. Toast in oven at 350°F for 5 to 7 minutes, or until light brown and aromatic. Cool slightly; chop.

In medium bowl, combine nuts, chicken, and cheese; refrigerate until ready to fill ravioli. Follow directions for preparing pasta sheets, using ravioli maker and cooking ravioli.

Sauce

- 1 *tablespoon olive oil*
- 1 *medium onion, chopped*
- 2 *cloves garlic, minced*
- 1 *can (28 oz.) crushed tomatoes*
- $\frac{1}{2}$ *cup white or red wine**
- $\frac{1}{4}$ *cup grated Parmesan cheese*
- $\frac{1}{4}$ *cup chopped fresh parsley*
- $\frac{1}{4}$ *cup chopped fresh basil or 2½ teaspoons dried basil*
- 2 *tablespoons chopped fresh oregano or 1-2 teaspoons dried oregano*
- 1 *bay leaf*
- 1-1½ *teaspoons salt*
- 1 *teaspoon sugar*

In large saucepan over medium heat, heat oil. Add onion; sauté until onion is tender. Add garlic; cook 1 minute longer. Add remaining ingredients; stir. Bring to boil; reduce heat and simmer 30 to 40 minutes, or until sauce is thick and flavors are blended. Serve hot over cooked ravioli.

Yield: 6 servings (12 to 15 ravioli with $\frac{1}{2}$ cup sauce per serving).

*If desired, water may be substituted.

Per serving: About 530 cal, 26 g pro, 66 g carb, 18 g total fat, 7 g sat fat, 175 mg chol, 980 mg sod.



FOR THE WAY IT'S MADE.™

® Registered trademark/™ Trademark/ the shape of the mixer is a registered trademark of KitchenAid, U.S.A.